ICS 52: Introduction to Software Engineering

Winter Quarter 2004

Professor Richard N. Taylor

Lecture Notes: CM, Management, and Evolution

Many slides taken from Ian Sommerville's text...

http://www.ics.uci.edu/~taylor/ICS_52_WQ04/syllabus.html



Irvine

Copyright 2004, Richard N. Taylor. Duplication of course material for any commercial purpose without written permission is prohibited.

A “Survival Fare” of Topics

- ◆ Configuration Management
- ◆ Maintenance and Evolution
- ◆ Project Management

Configuration management

- ◆ New versions of software systems are created as they change
 - For different machines/OS
 - Offering different functionality
 - Tailored for particular user requirements
- ◆ Configuration management is concerned with managing evolving software systems
 - System change is a team activity
 - CM aims to control the costs and effort involved in making changes to a system

System families

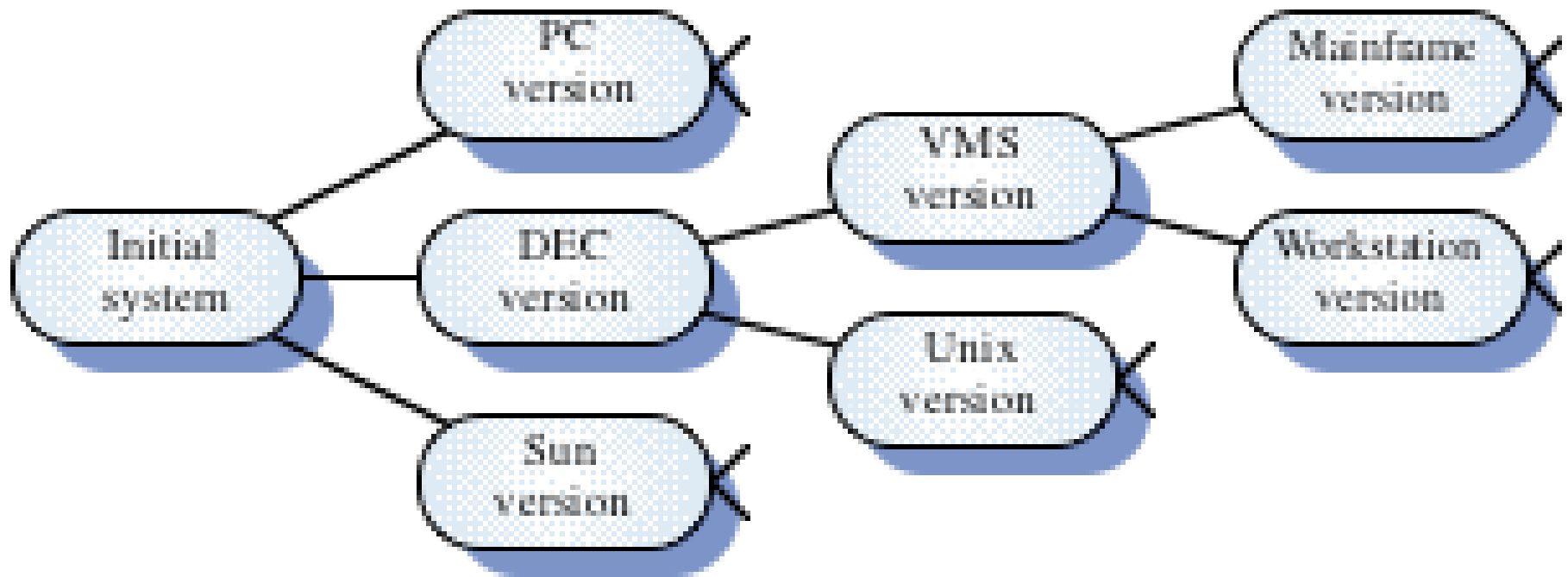

Configuration Hierarchy (for 1 family member)

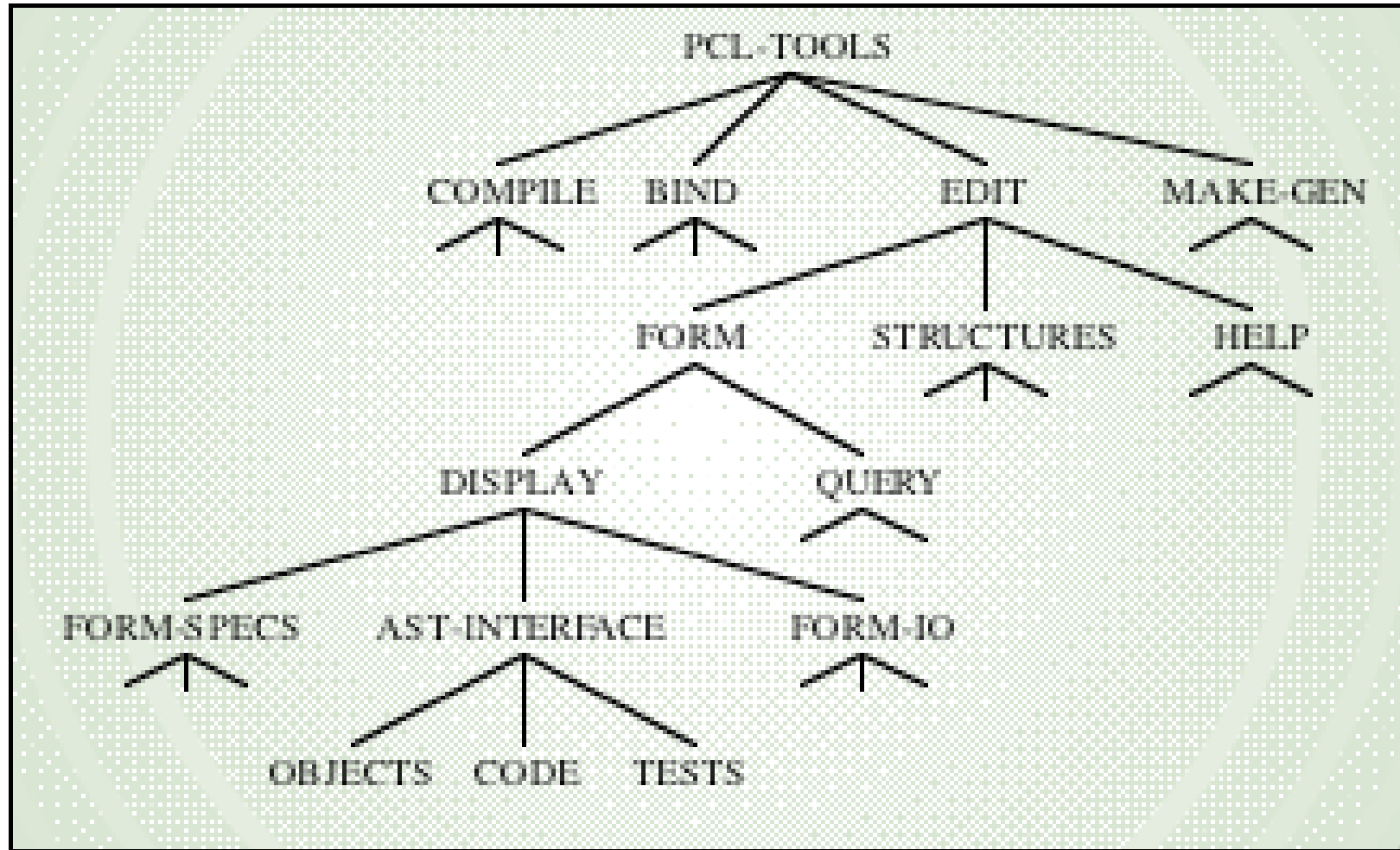

The configuration database

- ◆ All CM information should be maintained in a configuration database
- ◆ This should allow queries about configurations to be answered
 - Who has a particular system version?
 - What platform is required for a particular version?
 - What versions are affected by a change to component X?
 - How many reported faults in version T?
- ◆ The CM database should preferably be linked to the software being managed

Versions/variants/releases

- ◆ *Version* An instance of a system which is functionally distinct in some way from other system instances
- ◆ *Variant* An instance of a system which is **functionally** identical but **non-functionally** distinct from other instances of a system
- ◆ *Release* An instance of a system which is distributed to users outside of the development team

Version identification

- ◆ Procedures for version identification should define an unambiguous way of identifying component versions
- ◆ Three basic techniques for component identification
 - Version numbering
 - Attribute-based identification
 - Change-oriented identification

Version derivation structure

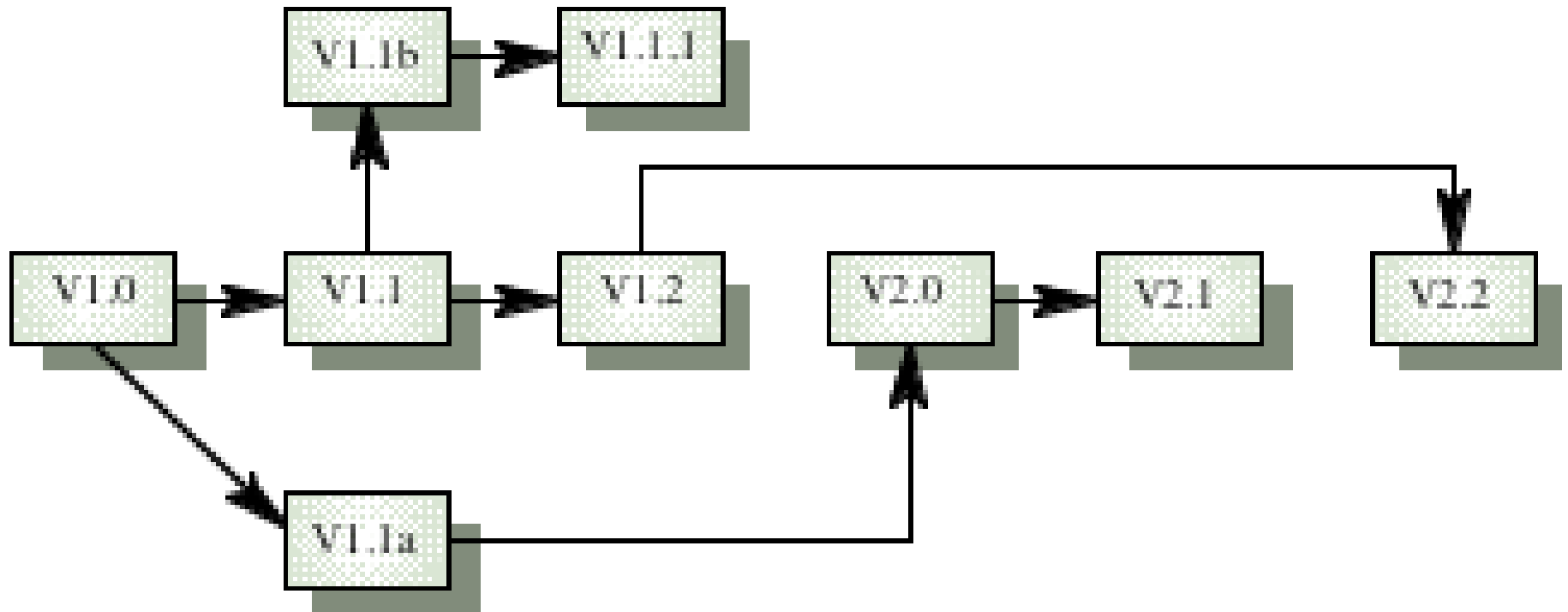

Version management tools

- ◆ Version and release identification
 - Systems assign identifiers automatically when a new version is submitted to the system
- ◆ Storage management.
 - System stores the differences between versions rather than all the version code
- ◆ Change history recording
 - Record reasons for version creation
- ◆ Independent development
 - Only one version at a time may be checked out for change. Parallel working on different versions

Delta-based versioning

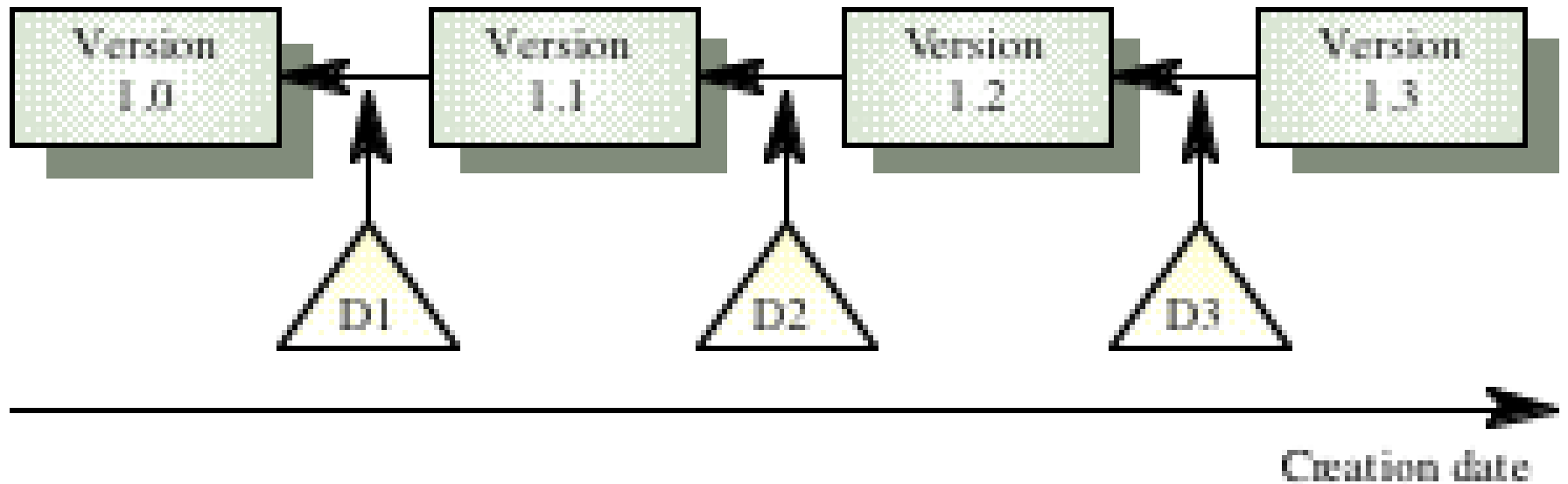

System building

- ◆ Building a large system is computationally expensive and may take several hours
- ◆ Hundreds of files may be involved
- ◆ System building tools may provide
 - A dependency specification language and interpreter
 - Tool selection and instantiation support
 - Distributed compilation
 - Derived object management

Make-oids

Component dependencies

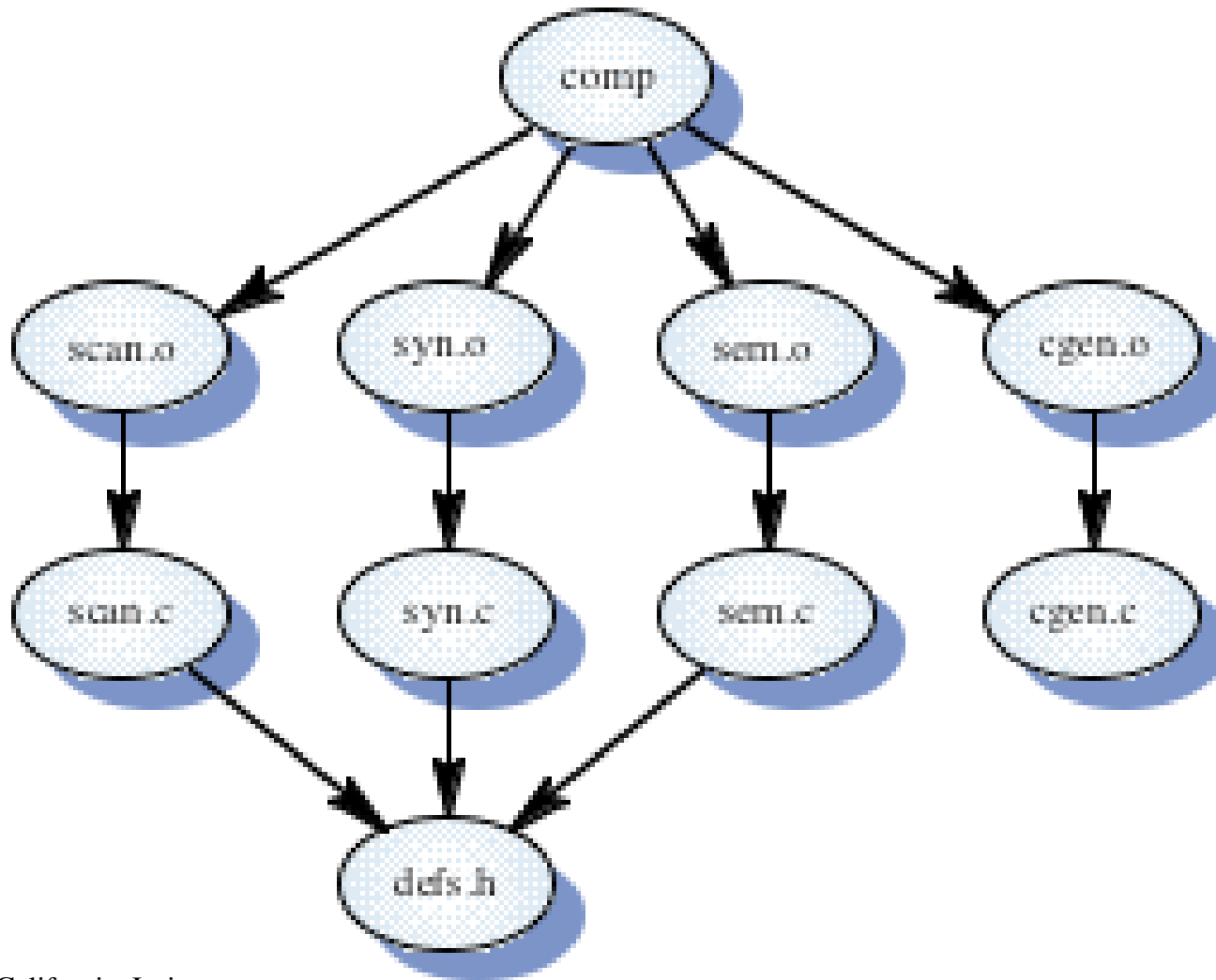

Types of maintenance

- ◆ Maintenance to repair software faults
 - Changing a system to correct deficiencies in the way meets its requirements
- ◆ Maintenance to adapt software to a different operating environment
 - Changing a system so that it operates in a different environment (computer, OS, etc.) from its initial implementation
- ◆ Maintenance to add to or modify the system's functionality
 - Modifying the system to satisfy new requirements

Distribution of maintenance effort

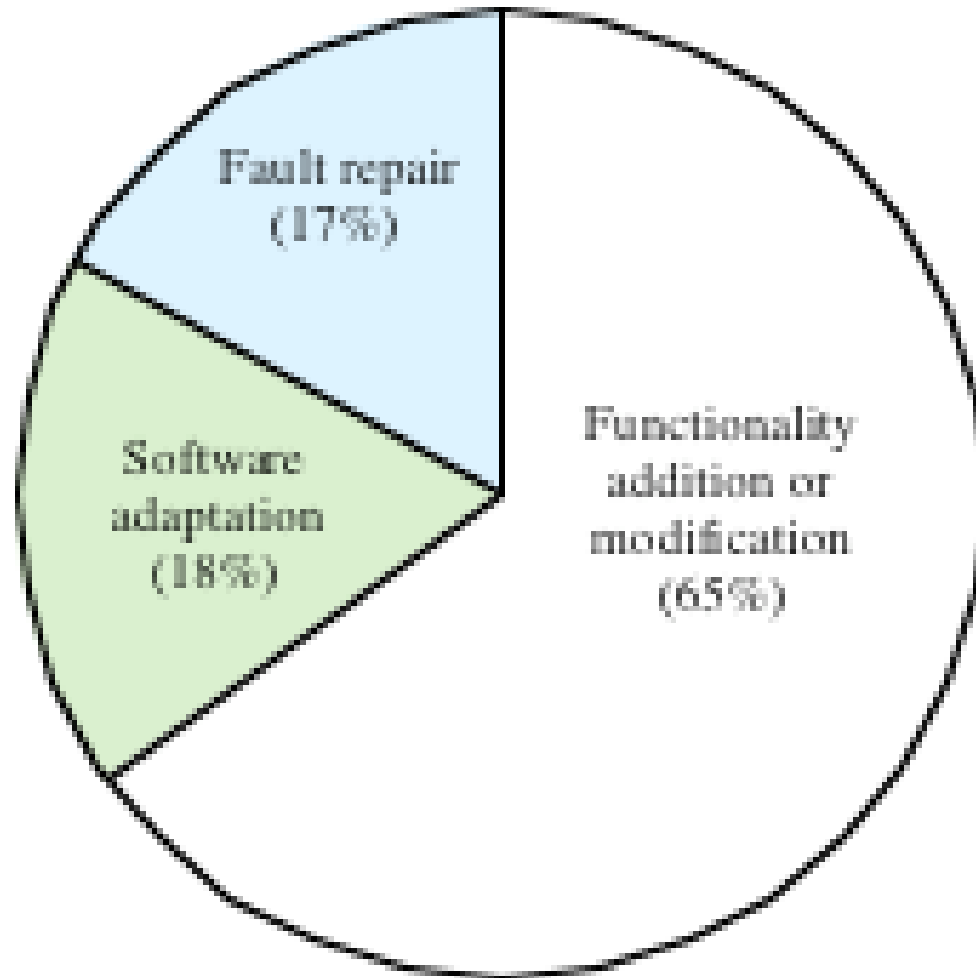

Management of Software Engineering

- ◆ Planning
 - Objectives
 - Necessary resources
 - How to acquire resources
 - How to achieve goals
- ◆ Organizing
 - From small group structure to large organizations
- ◆ Staffing: the key resource in software development
- ◆ Directing
 - ensure continuing understanding and buy-in
- ◆ Controlling
 - Measure performance and take corrective action when necessary

Project Control: Task-based

- ◆ Work Breakdown Structures
 - Hierarchical statement of the tasks to be performed
 - » a subset of a statement of the process which will be followed
- ◆ “Off-line” management schemes
 - Gantt charts
 - » Bar charts where length of bar proportional to the length of time planned for the activity
 - » Can be used as a statement of schedule
 - » Useful for analysis of resource deployment (e.g. maximum number of engineers needed at any one time)
 - PERT charts
 - » A network of activities showing dependencies (precedence relationships)
 - » Exposes critical path
 - » Shows maximal possible parallelism in project execution

Gantt Chart Example

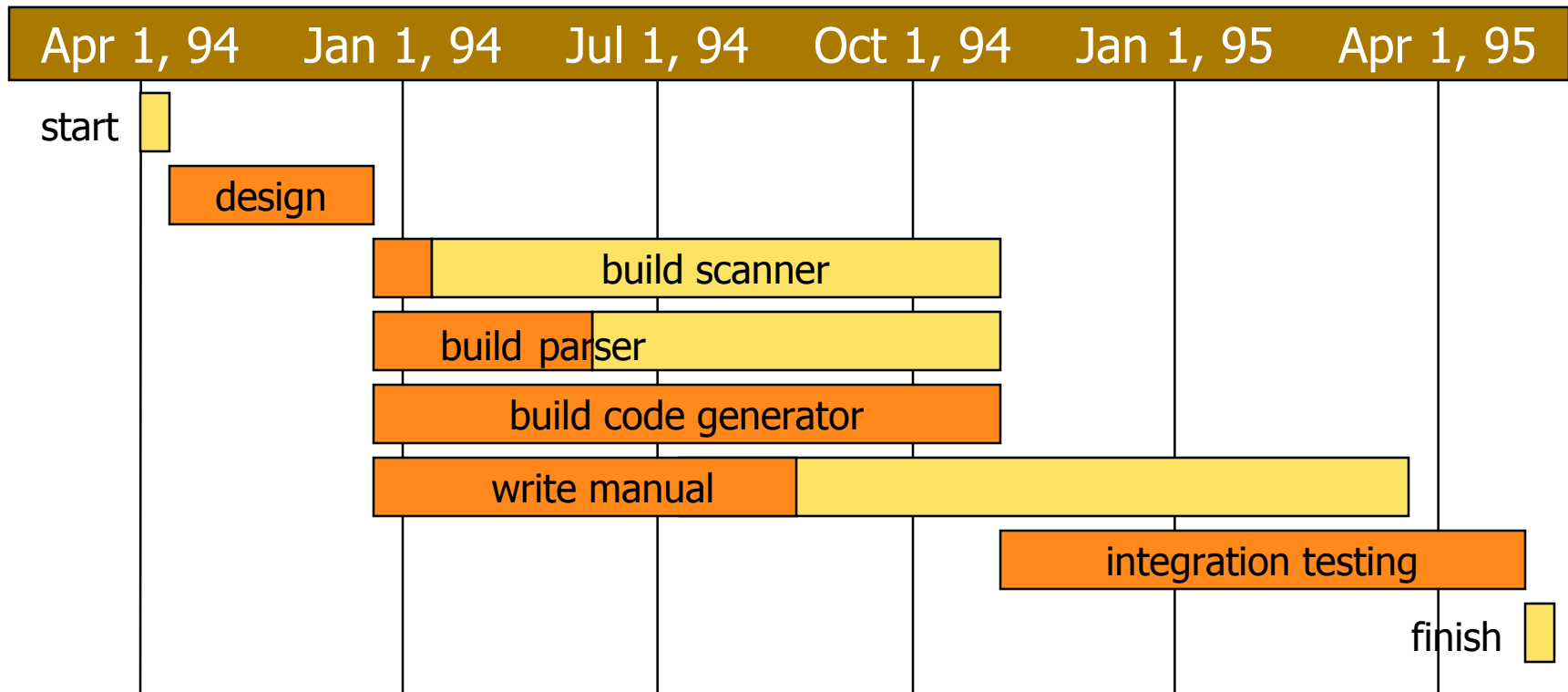

PERT Chart Example

